



**ASOLO ANTONIO CITTERIO 2020**  
**BEDS/BED ACCESSORIES**

---

## ASOLO | ANTONIO CITTERIO | 2020

**PRigid base** in plywood with polyurethane foam padding, covered with a protective laminated fabric

**Storage base that opens**, metal platform with wood slats. Bedframe in plywood with polyurethane foam padding, covered with a protective laminated fabric

**Base with metal platform and wood slats**, adjustable to four height positions: 1st 4.5 cm, 2nd 7.3 cm, 3rd 9.5 cm, 4th 12.6 cm; double-check there is sufficient space to support the platform inside the bed, as shown in the figure

Bedframe in plywood with polyurethane foam padding, covered with a protective laminated fabric

**Headboard** in metal with molded polyurethane and polyester fiber padding, covered with a protective laminated fabric

**Feet** in tubular metal with epoxy powder-coat finish

**Upholstery** is removable in both the fabric and leather versions

**Please note: the platform with wooden slats is delivered divided in 2 pieces, except for the version with storage base**

COD. 0270L1

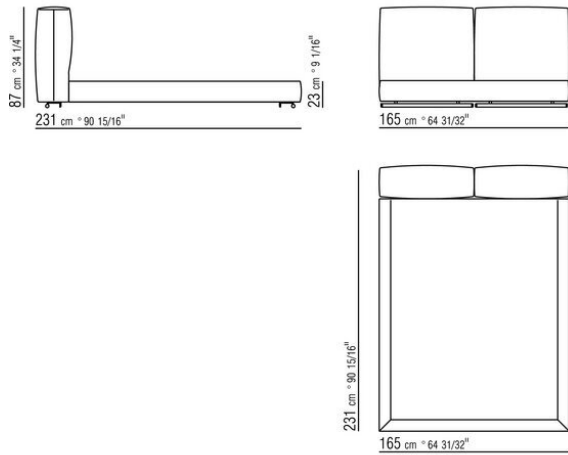

COD. 0270L2

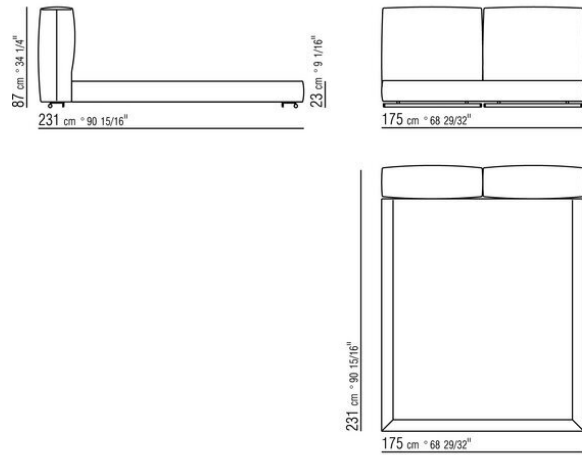

COD. 0270L3

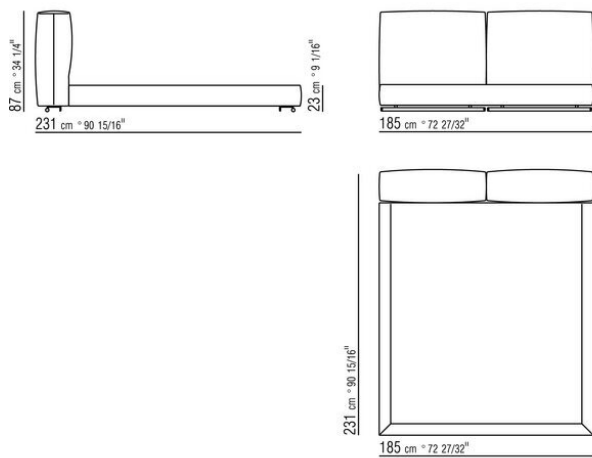

COD. 0270L5

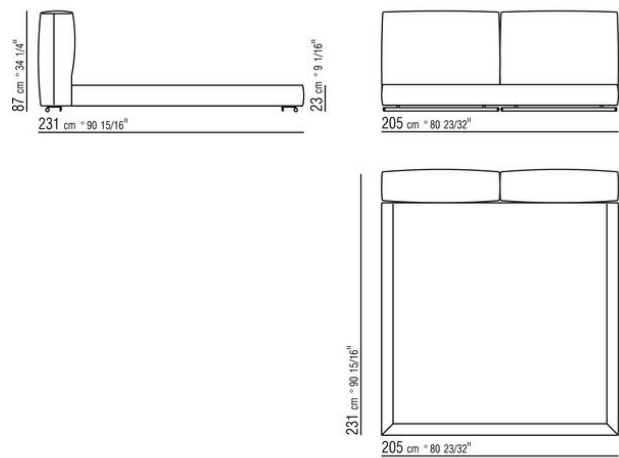

COD. 0270M1

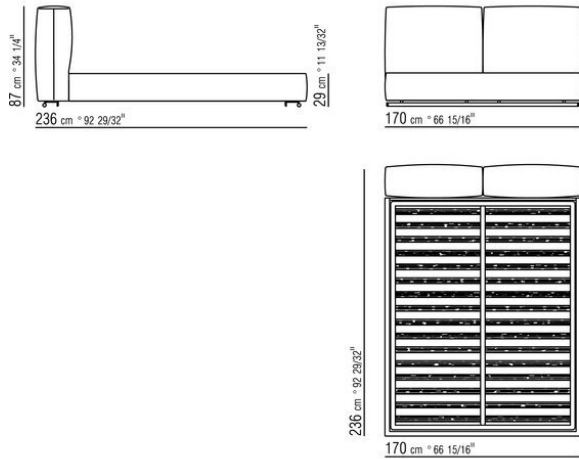

COD. 0270M2

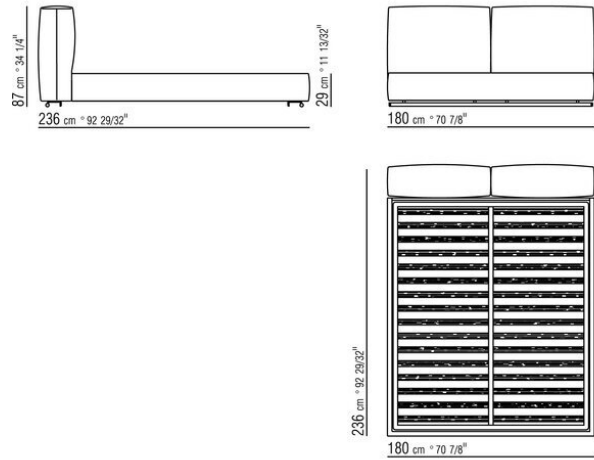

COD. 0270M3

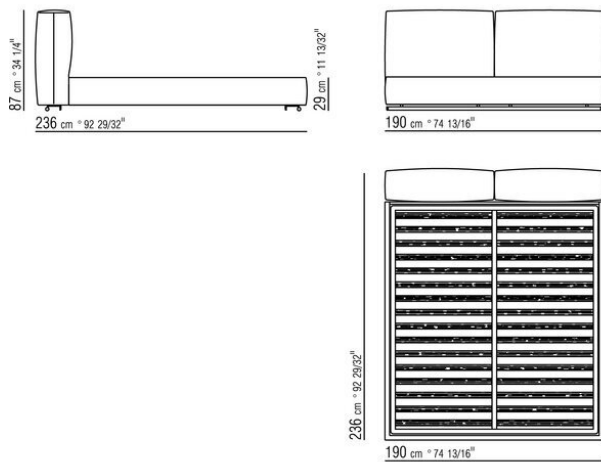

COD. 0270M5

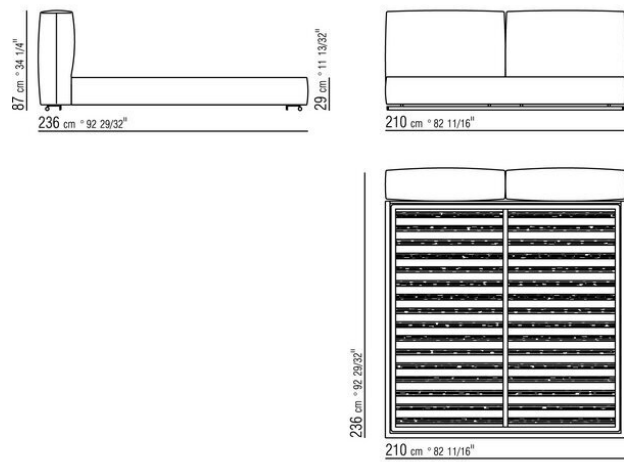

COD. 0270M6

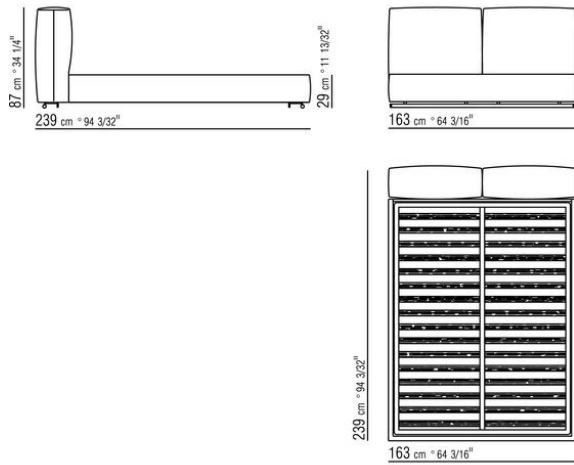

COD. 0270M8

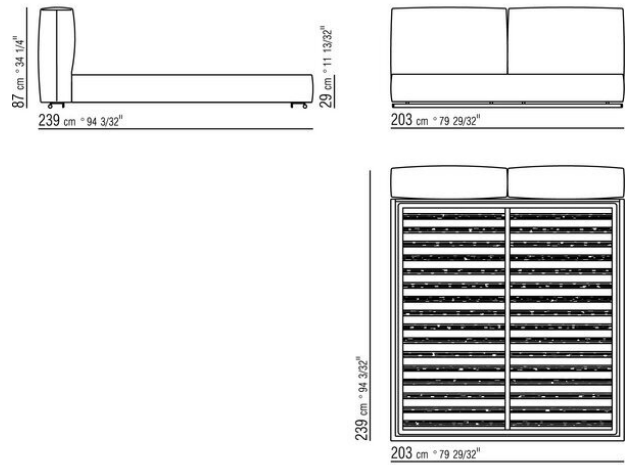

COD. 0270N1

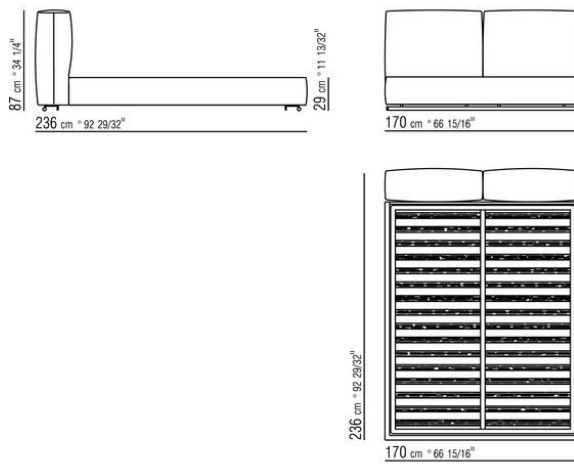

COD. 0270N2

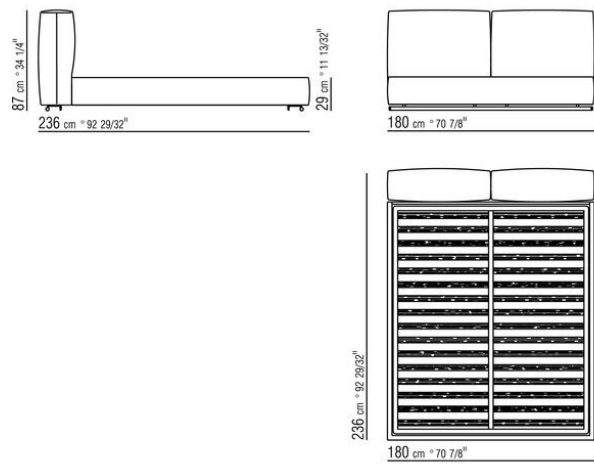

COD. 0270N3

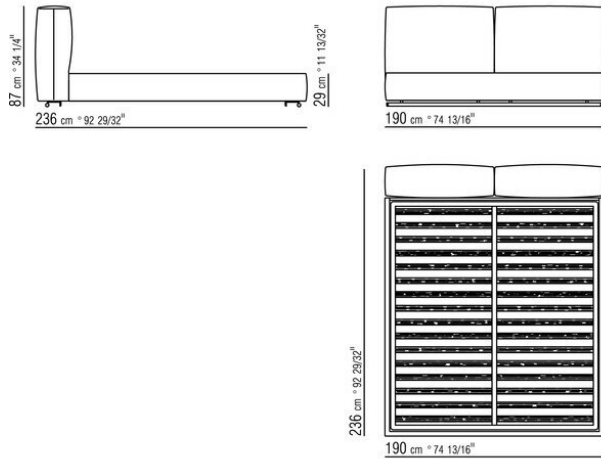

COD. 0270N5

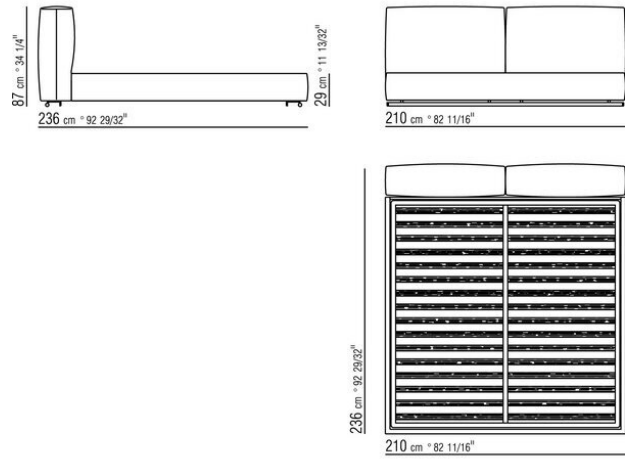

COD. 0270N6

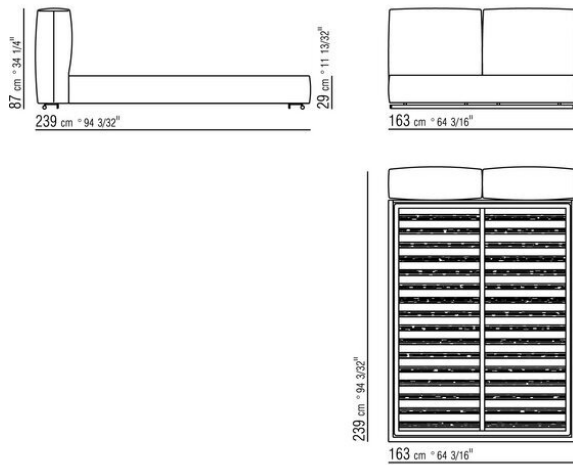

COD. 0270N8

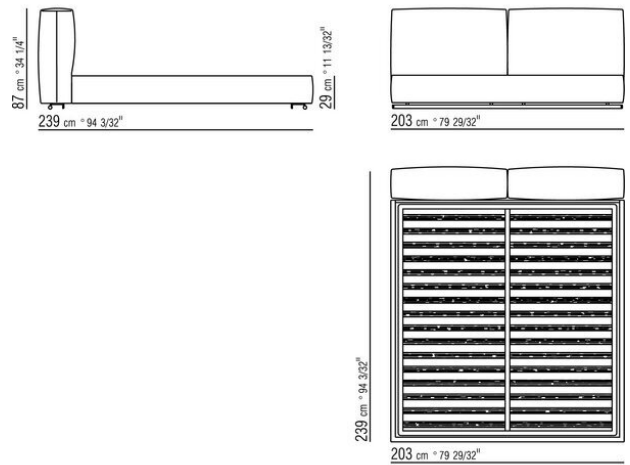

COD. 0270VA

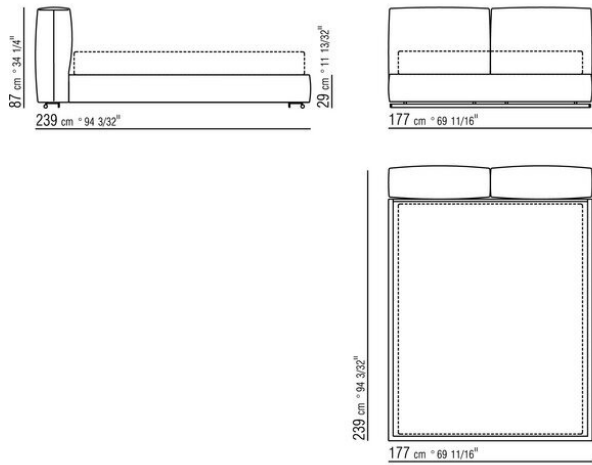

COD. 0270VC

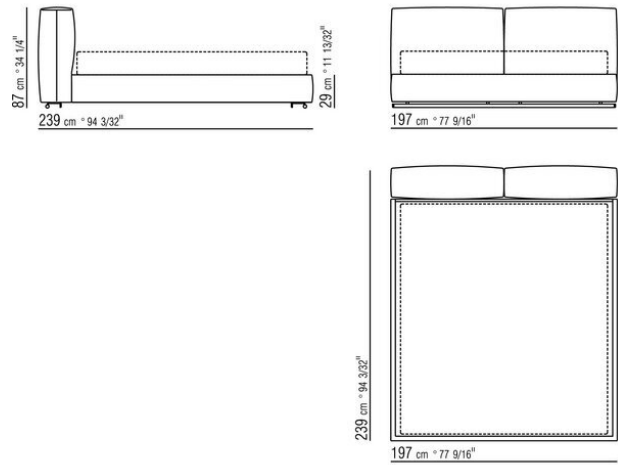

COD. 0270VE

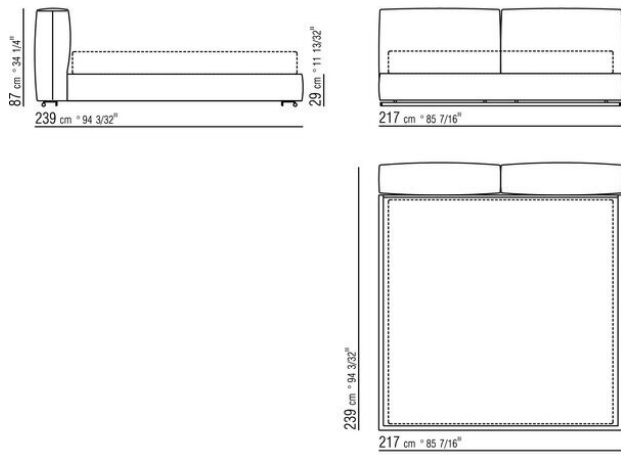

COD. 0270P1

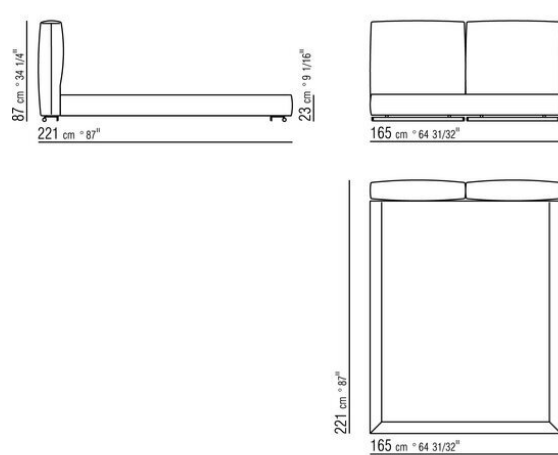

COD. 0270P2

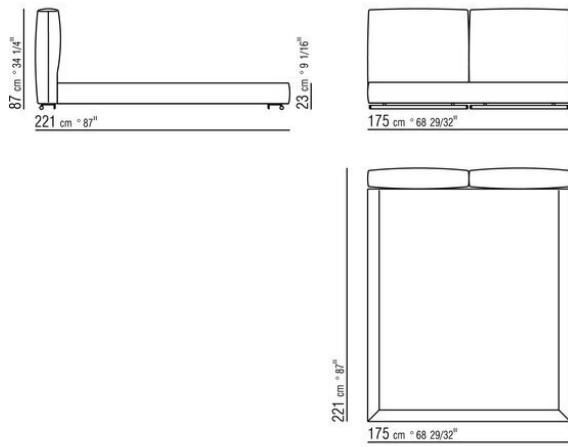

COD. 0270P3

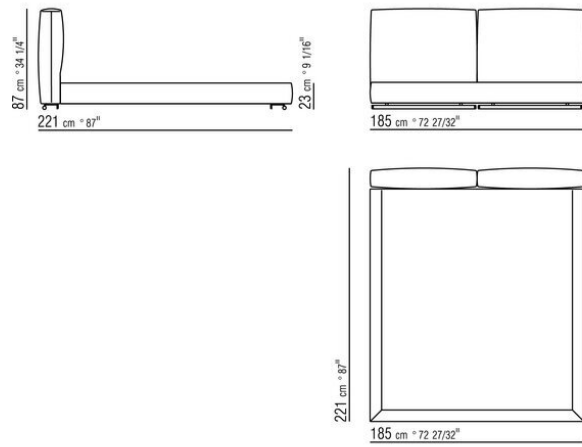

COD. 0270P5

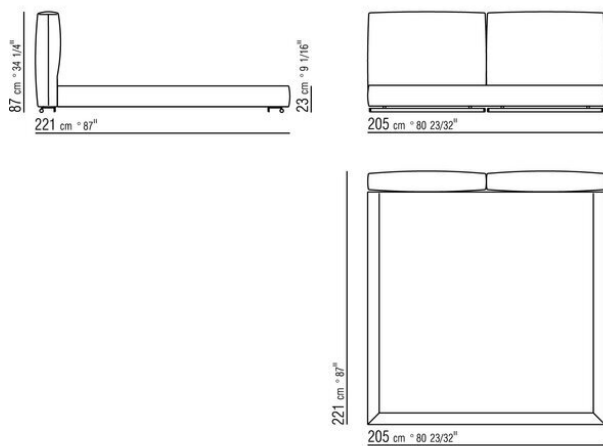

COD. 0270Q1

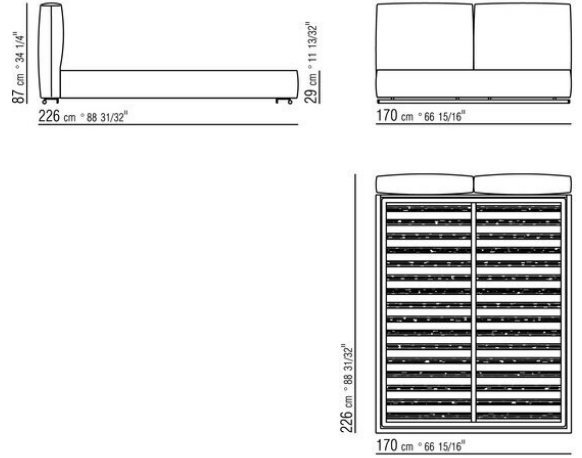



COD. 0270Q2

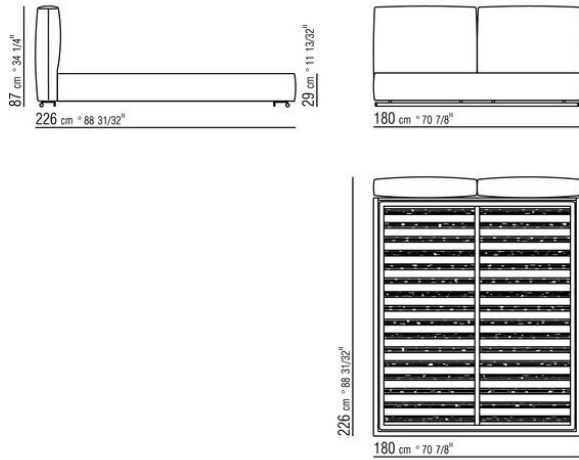

COD. 0270Q3

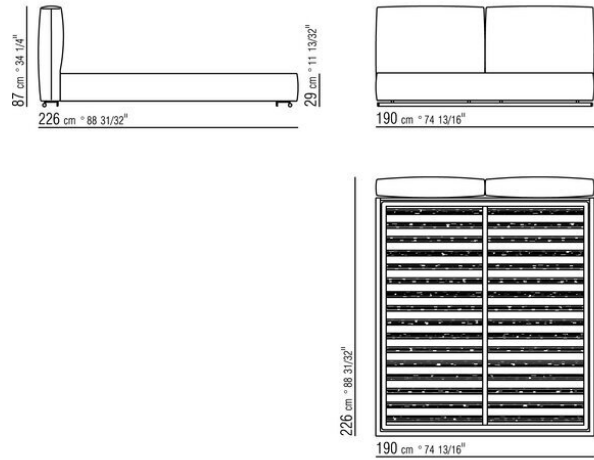

COD. 0270Q5

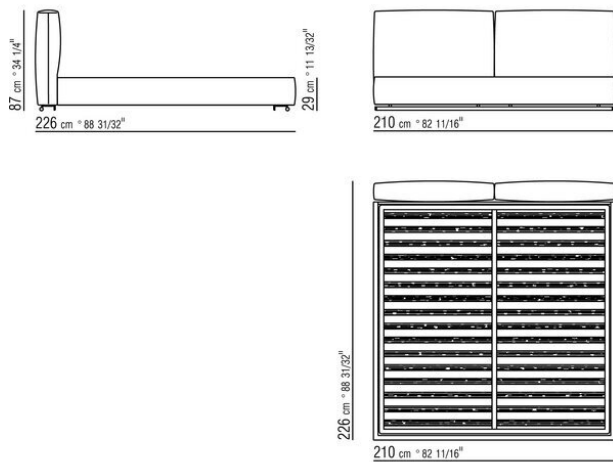

COD. 0270Q6

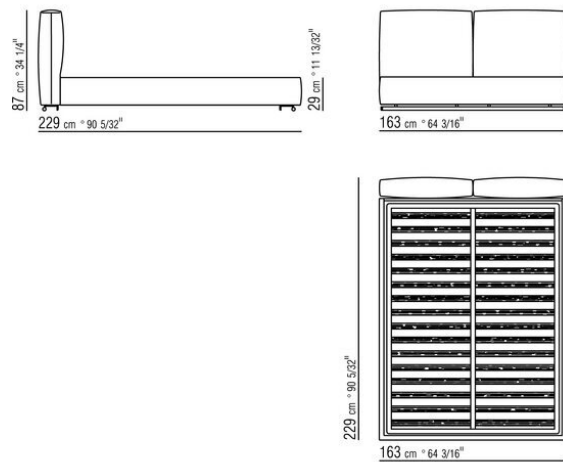

COD. 0270Q8

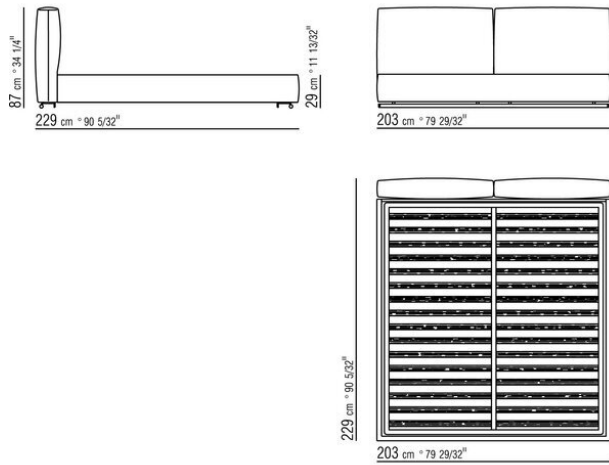

COD. 0270R1

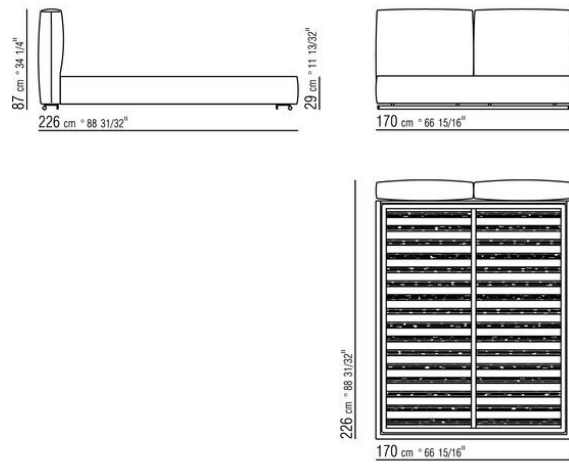

COD. 0270R2

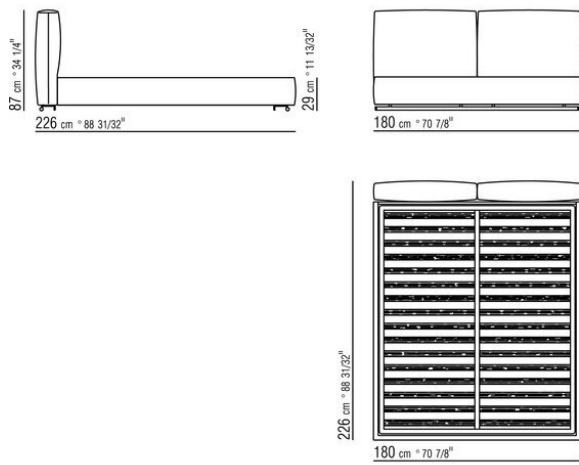

COD. 0270R3

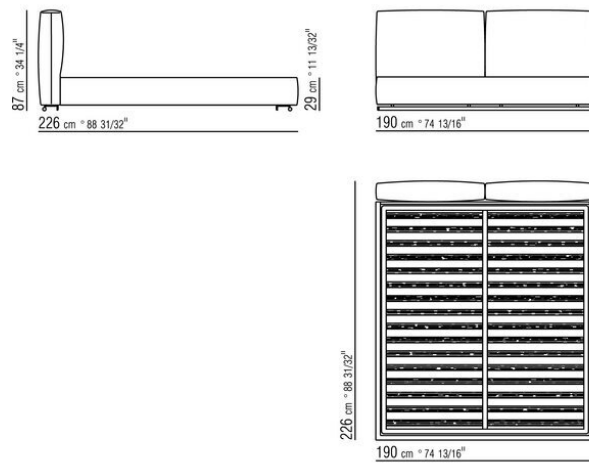

COD. 0270R5

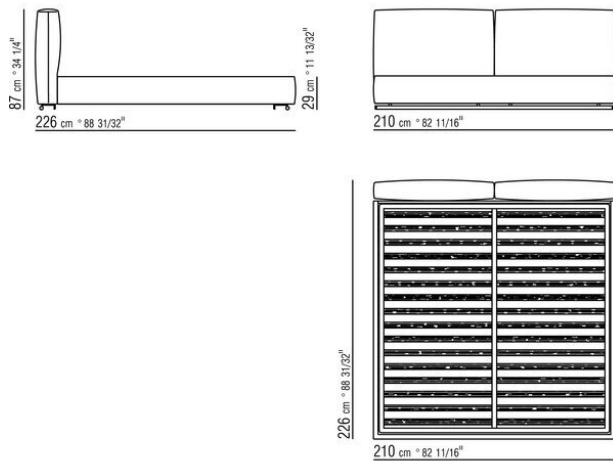

COD. 0270R6

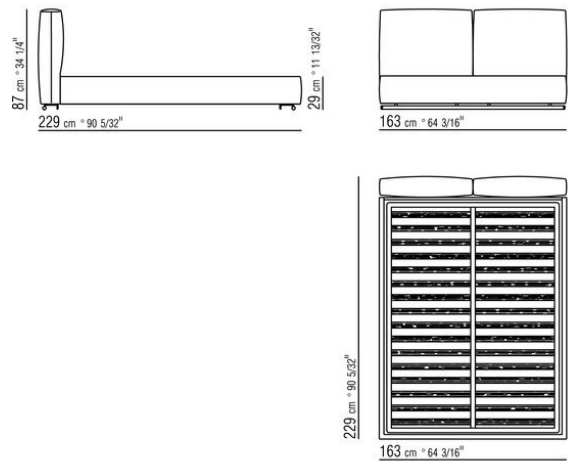

COD. 0270R8

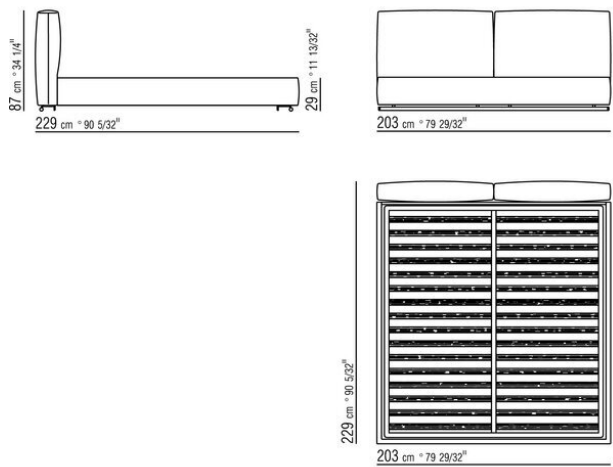

COD. 0270YA

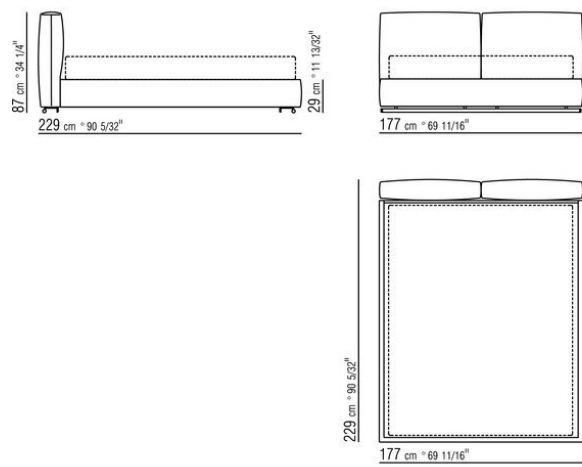

COD. 0270YC

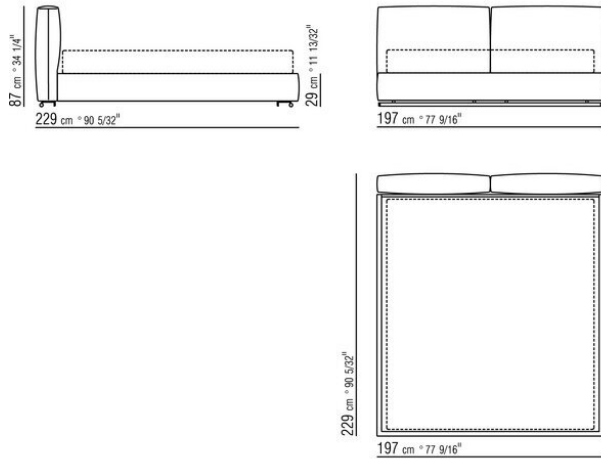

COD. 0270YE

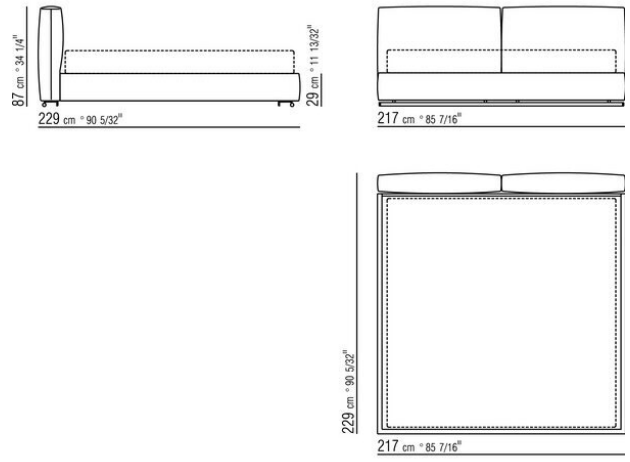

0270XA

N.2 COD.027070 - ARMREST CM.106 x18

N.1 COD.027005 - UNIT CM.230 x106

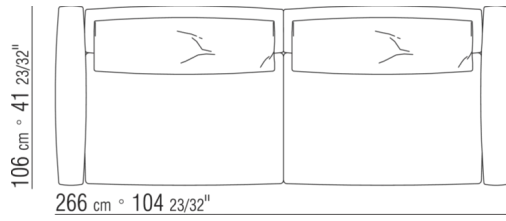

0270XB

N.2 COD.027071 - ARMREST CM.106 x29

N.1 COD.027005 - UNIT CM.230 x106

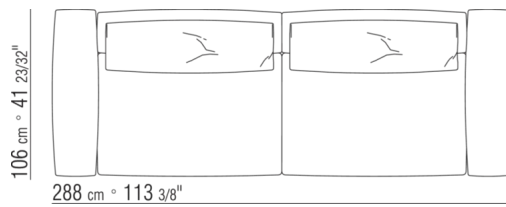

0270XC

N.2 COD.027074 - ARMREST CM.116 x18

N.1 COD.027016 - UNIT CM.255 x116

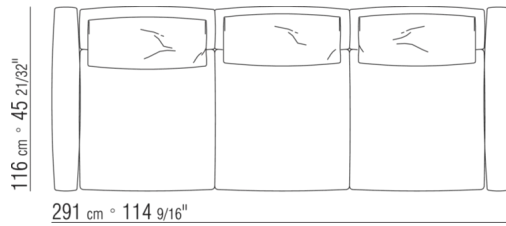

0270XD

N.2 COD.027075 - ARMREST CM.116 x29

N.1 COD.027016 - UNIT CM.255 x116

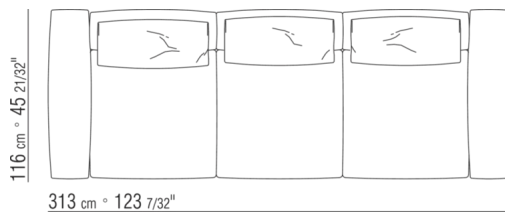

0270XE

N.2 COD.027004 - UNIT CM.170 x106

N.1 COD.027050 - OTTOMAN CM.85 x106

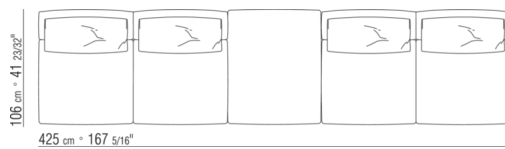

0270XF

N.1 COD.027075 - ARMREST CM.116 x29

N.1 COD.027015 - UNIT CM.230 x116

N.2 COD.027071 - ARMREST CM.106 x29

N.1 COD.027005 - UNIT CM.230 x106

N.1 COD.027099 - CUSHION CM.73 x53

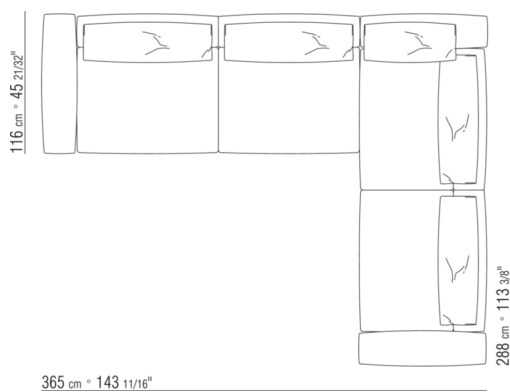

0270XG

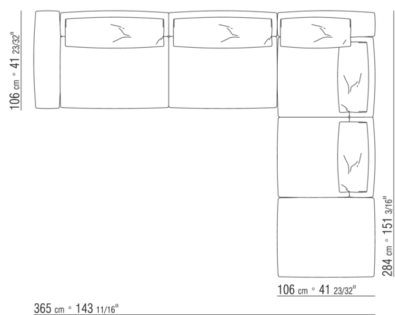

- N.2 COD.027071 - ARMREST CM.106 x29
- N.1 COD.027005 - UNIT CM.230 x106
- N.1 COD.027025 - TERMINAL UNIT L CM.255 x106
- N.1 COD.027099 - CUSHION CM.73 x53

0270XH

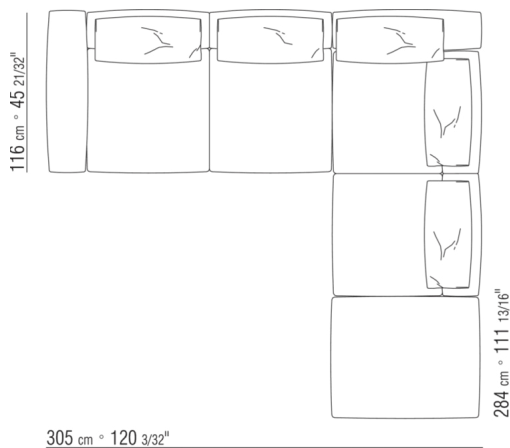

- N.1 COD.027075 - ARMREST CM.116 x29
- N.1 COD.027014 - UNIT CM.170 x116
- N.1 COD.027071 - ARMREST CM.106 x29
- N.1 COD.027025 - TERMINAL UNIT L CM.255 x106
- N.1 COD.027099 - CUSHION CM.73 x53

0270XK

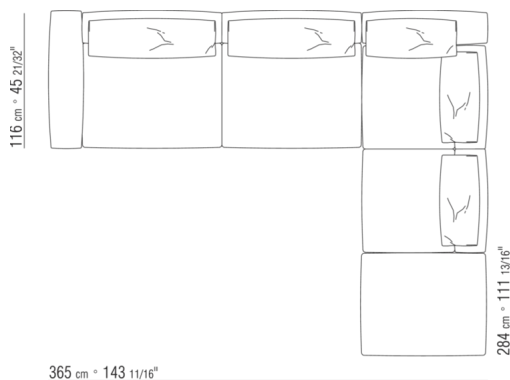

- N.1 COD.027075 - ARMREST CM.116 x29
- N.1 COD.027015 - UNIT CM.230 x116
- N.1 COD.027071 - ARMREST CM.106 x29
- N.1 COD.027025 - TERMINAL UNIT L CM.255 x106
- N.1 COD.027099 - CUSHION CM.73 x53

0270XL

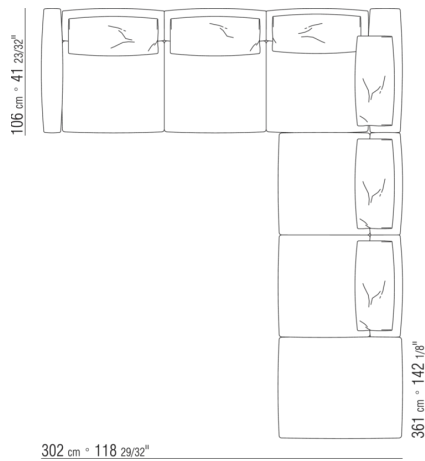

- N.1 COD.027070 - ARMREST CM.106 x18
- N.1 COD.027006 - UNIT CM.255 x106
- N.1 COD.027071 - ARMREST CM.106 x29
- N.1 COD.027025 - TERMINAL UNIT L CM.255 x106
- N.1 COD.027099 - CUSHION CM.73 x53

0270XM

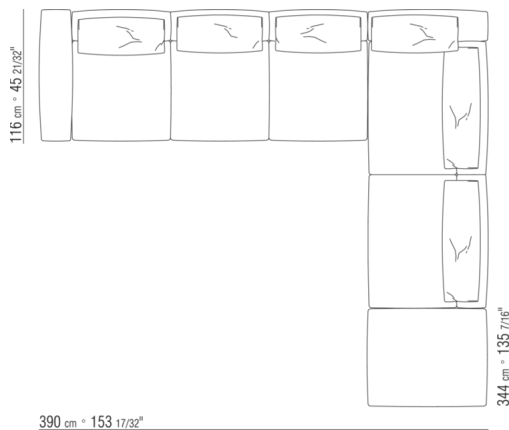

- N.1 COD.027075 - ARMREST CM.116 x29
- N.1 COD.027016 - UNIT CM.255 x116
- N.1 COD.027071 - ARMREST CM.106 x29
- N.1 COD.027027 - TERMINAL UNIT L CM.315 x106
- N.1 COD.027099 - CUSHION CM.73 x53

0270XN

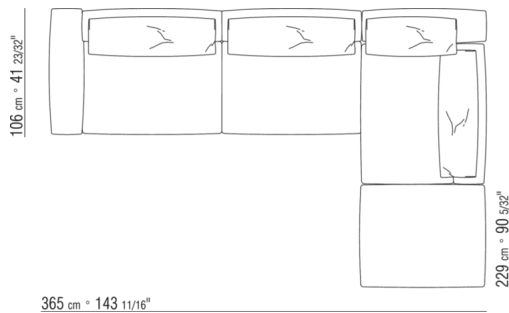

- N.2 COD.027071 - ARMREST CM.106 x29
- N.1 COD.027005 - UNIT CM.230 x106
- N.1 COD.027003 - UNIT CM.115 x106
- N.1 COD.027050 - OTTOMAN CM.85 x106
- N.1 COD.027099 - CUSHION CM.73 x53