

FLEXFORM

MADE IN ITALY



ADDA ANTONIO CITTERIO 2017

DIVANI | DIVANI COMPONENTI | POUF SOFAS | SECTIONAL SOFAS | OTTOMANS

FLEXFORM Spa

Via Einaudi 23/25 20821 Meda (MB) Italy | Tel. +39 0362 3991 | Fax +39 0362 399228 | info@flexform.it | www.flexform.it

ADDA | ANTONIO CITTERIO | 2017

TIPOLOGIE DIVANI/DIVANI COMPONENTI/POUF -
POLTRONE/POUF

PRODOTTO DIVANO - DIVANO COMPONENTI

STRUTTURA IN METALLO CON MATERASSINO IN
POLIURETANO RIVESTITA IN CUIO RIGENERATO
GRIGIO

CUSCINI SEDUTA IN PIUMA D'OCA CON INSERTO
IN MATERIALE INDEFORMABILE

SCHIENALE IN POLIURETANO ESPANSO, FIBRA
E PIUMA CON INSERTO IN METALLO

BRACCIOLI IN POLIURETANO ESPANSO E PIUMA
CON INSERTO IN METALLO

CUSCINI IN PIUMA D'OCA SU RICHIESTA CON
SUPPLEMENTO DI PREZZO

PIEDI IN METALLO VERNICIATO (FINITURE
DA VERIFICARE SUL LISTINO PREZZI)

RIVESTIMENTO IN TESSUTO O PELLE
SFODERABILE

CATEGORIES SOFAS/SECTIONAL SOFAS/
OTTOMANS - ARMCHAIRS/OTTOMANS

PRODUCT SOFA - SECTIONAL SOFA - POUF

FRAME METAL WITH POLYURETHANE PADDING
COVERED IN GREY RECONSTITUTED HIDE

SEAT CUSHIONS IN DOWN WITH FOAM INNER
CORE

BACK CUSHIONS IN POLYURETHANE, FIBERS
AND DOWN WITH METAL INSERT

ARMRESTS IN POLYURETHANE AND DOWN WITH
METAL INSERT

PILLOWS IN DOWN UPON REQUEST WITH UP
CHARGE

FEET IN METAL (FINISHES TO BE VERIFIED IN THE
PRICE LIST)

UPHOLSTERY REMOVABLE FABRIC OR LEATHER
COVERS

TIPOLOGIE SOFA / SOFAMODULE / POUF -
SESSEL/HOCKER

PRODUKT SOFA - SOFAMODULE - POUF

GESTELL METALLGESTELL MIT
POLYURETHANPOLSTERUNG UND

WIEDERVERWERTETEM GRAUEN KERNLEDER

SITZKISSEN DAUNENKISSEN MIT

UNVERFORMBAREN KERN

RÜCKENLEHNE POLYURETHANSCHAUM,
DACRONFLOCKEN UND DAUNEN MIT

METALLHALTERUNGEN

ARMLEHNEN POLYURETHANSCHAUM UND DAUNEN

MIT METALLHALTERUNGEN

KISSEN DAUNENKISSEN AUF WUNSCH GEGEN

MEHRPREIS SEPARAT

FÜSSE METALLFÜSSE (FARBEN SIEHE PREISLISTE)

BEZÜGE ABZIEHBARE STOFF- UND LEADERBEZÜGE

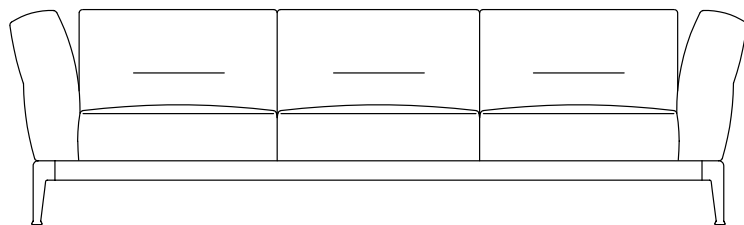





COD 236A2

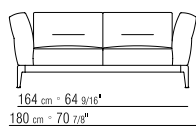
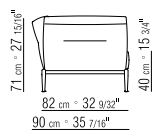

COD 236A4

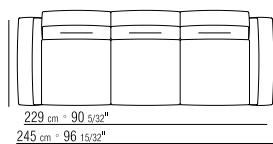
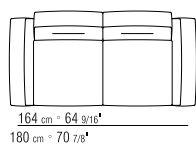
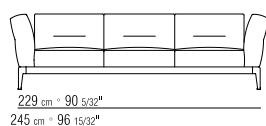

COD 236B1

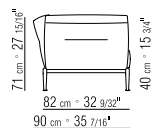

COD 236B3

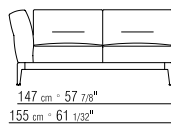

COD 236B5

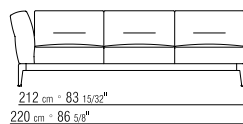

COD 236C3

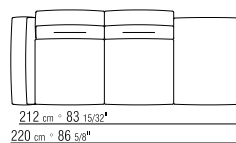
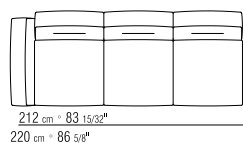
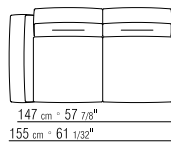
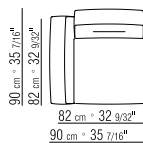
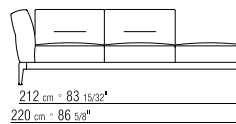

COD 236C1

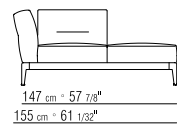
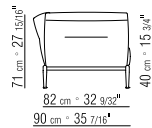

COD 236D1

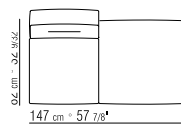
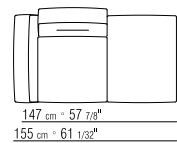
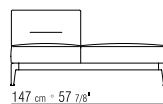
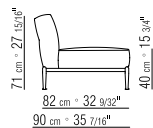

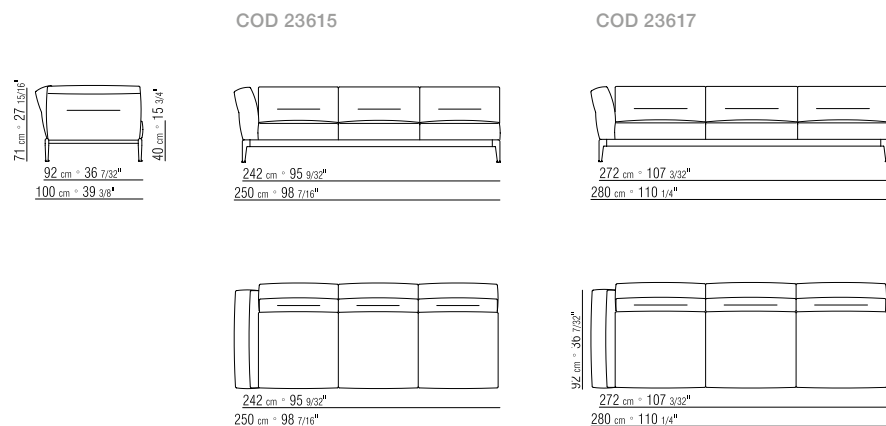
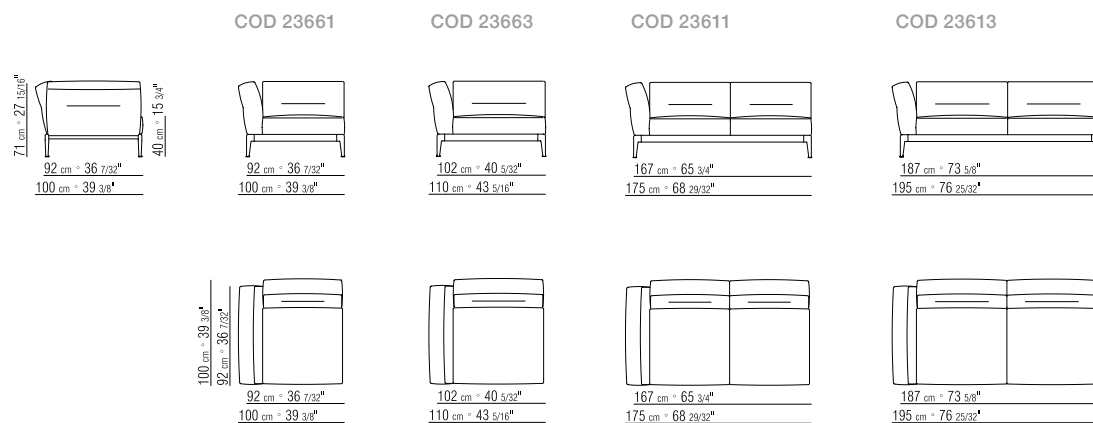
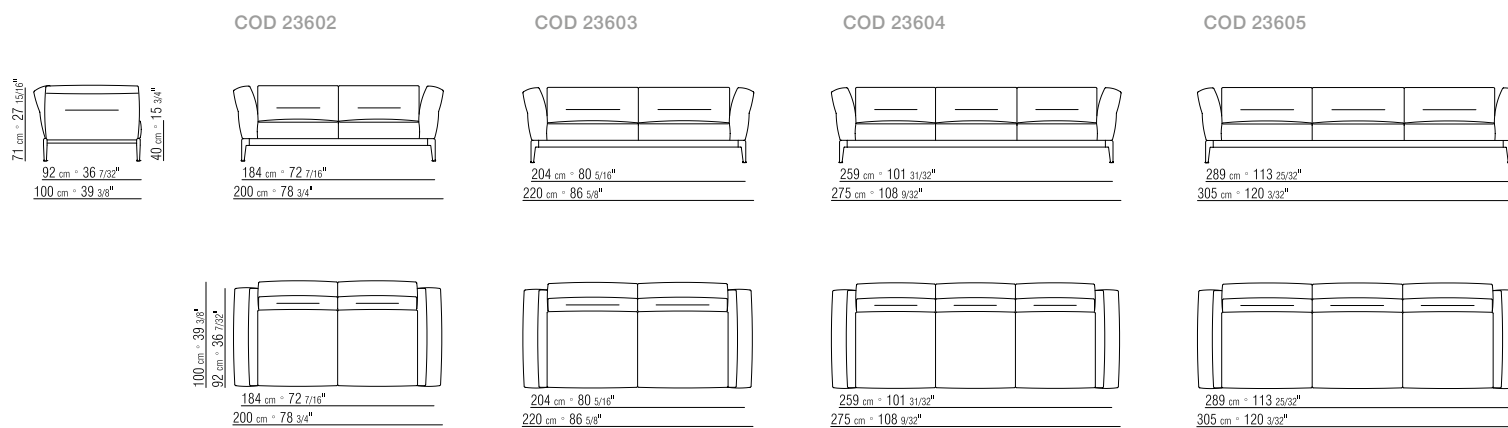

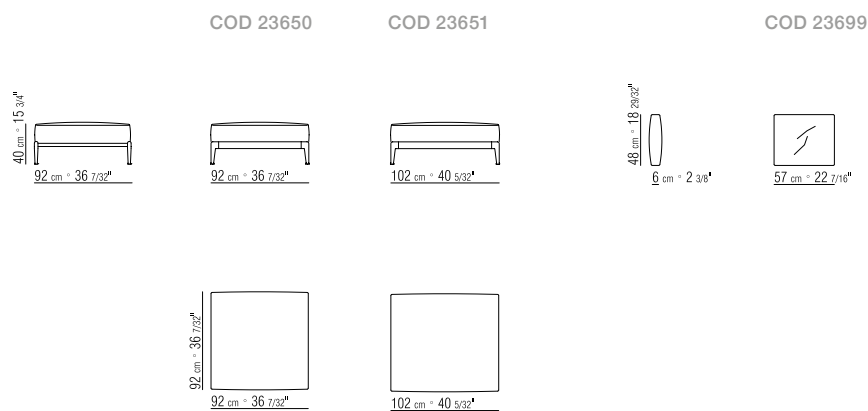
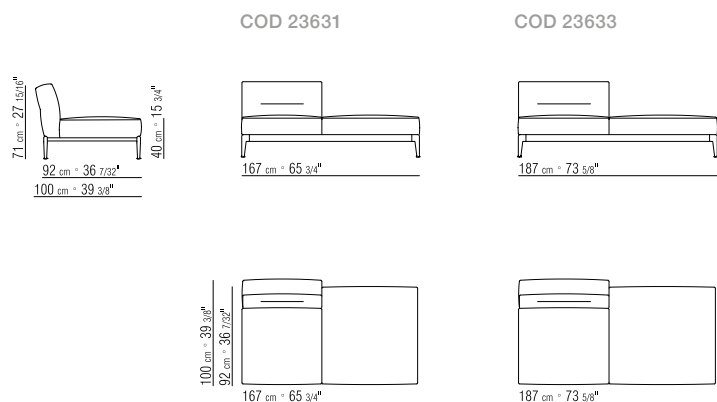
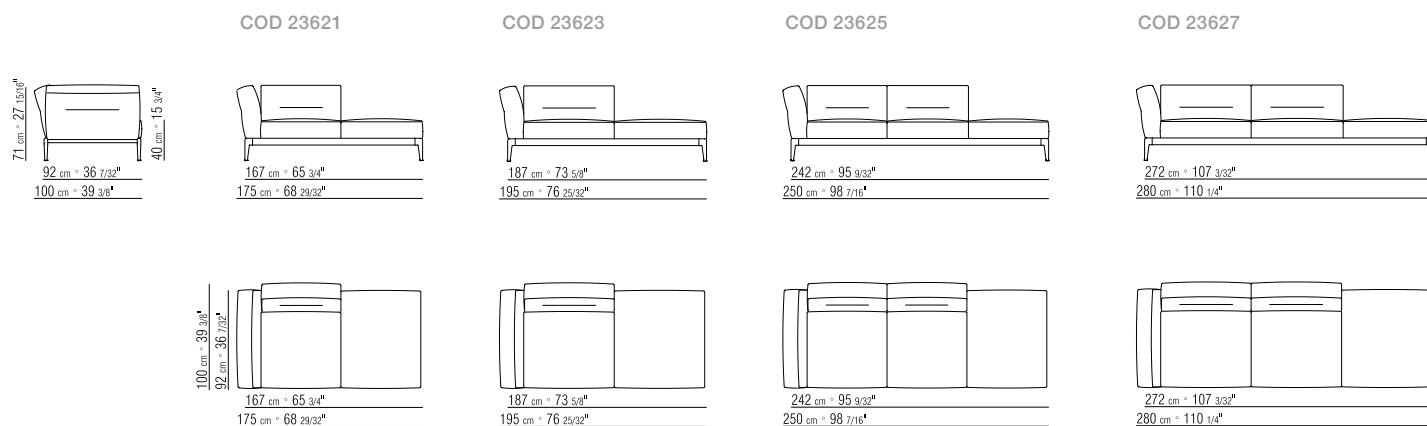

236XA

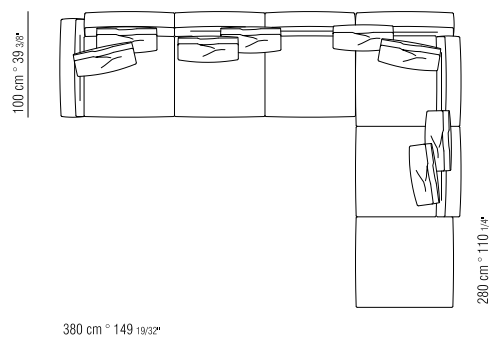

N.1 COD.23617 FIANCO SX CM.280
N.1 COD.23627 FIANCO TERMINALE SX CM.280
N.8 COD.23699 CUSCINO CM.57X48

*N.1 COD.23617 END UNIT L CM.280
N.1 COD.23627 LONG CORNER L CM.280
N.8 COD.23699 CUSHION CM.57X48*

236XA

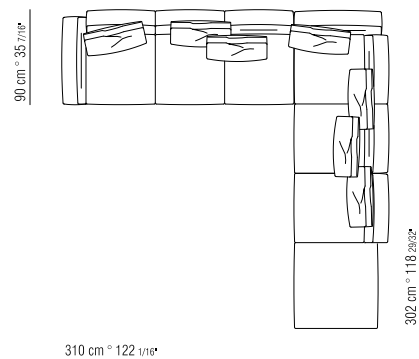

N.1 COD.236B5 - FIANCO SX CM.220X90
N.1 COD.236B3 - FIANCO SX CM.155X90
N.1 COD.236D1 - ELEMENTO TERMINALE SX CM.147X90
N.7 COD.23699 - CUSCINO CM.57X48

*N.1 COD.236B5 - END UNIT L CM.220X90
N.1 COD.236B3 - END UNIT L CM.155X90
N.1 COD.236D1 - END UNIT L CM.147X90
N.7 COD.23699 - CUSHION CM.57X48*